

7700 Series

OPERATING
MANUAL

FM Portable Radio

Intrinsically-Safe
SMARTNET™, SmartZone®
Conventional



 **EFJohnson®**



LAND MOBILE PRODUCT WARRANTY - The manufacturer's warranty statement for this product is available from your product supplier or from the E.F. Johnson Company, 299 Johnson Avenue, Box 1249, Waseca, MN 56093-0514. Phone (507) 835-6222.



Copyright© 2000 by the E.F. Johnson Company

The E.F. Johnson Company, which was founded in 1923, provides wireless communication systems solutions for public safety, government, and commercial customers. The company designs, manufactures, and markets conventional and trunked radio systems, mobile and portable subscriber radios, repeaters, and Project 25 digital radio products.

Viking Head/EFJohnson logo and Call Guard® are trademarks of the E.F. Johnson Company. SMARTNET™, SmartZone®, Call Alert™, Enhanced Private Conversation™, and Private Conversation II™ are trademarks of Motorola, Inc. All other company and/or product names used in this manual are trademarks and/or registered trademarks of their respective manufacturer.

SAFETY INFORMATION

The FCC has adopted a safety standard for human exposure to RF energy. Proper operation of this radio under normal conditions results in user exposure to RF energy below the Occupational Safety and Health Act and Federal Communication Commission limits.

WARNING

- DO NOT allow the antenna to touch or come in very close proximity with the eyes, face, or any exposed body parts while the radio is transmitting.
- DO NOT operate this transceiver in flammable or explosive atmospheres that are not listed on the label on the back of the transceiver.
- DO NOT operate the radio near electrical blasting caps. Be sure to turn it off in areas posted “Blasting Area” or “Turn Off Two-Way Radio”. Remote controlled RF devices are sometimes used to set off explosives.
- DO NOT open this transceiver or permit it to be serviced by anyone that is not authorized by the Factory Mutual Research Corporation to repair E.F. Johnson intrinsically safe radios.
- DO NOT operate the radio without the proper antenna installed. A minor skin burn can result if you touch a broken or damaged antenna. Replace the antenna only with the correct E.F. Johnson replacement.
- DO NOT allow children to operate or play with this radio. They could injure themselves, damage the radio, or make calls that increase your bill.
- DO NOT use unapproved battery packs. Use only E.F. Johnson Intrinsically Safe Battery Pack, Part No. 587-8150-136.
- DO NOT remove, install, or recharge the battery pack while in a hazardous location. Also, DO NOT dispose of the battery pack in fire because it may explode.

- DO NOT use accessories that have not been approved by the Factory Mutual Corporation for use with this transceiver.

NOTE: The above warning list is not intended to include all hazards that may be encountered when using this radio.

This device complies with Part 15 of the FCC rules. Operation is subject to the condition that this device does not cause harmful interference. In addition, changes or modifications to this equipment not expressly approved by the E.F. Johnson Company could void the user's authority to operate this equipment (FCC rules, 47CFR Part 15.19).

OTHER IMPORTANT OPERATING INFORMATION

Vehicle Operation While Using Transceiver - Observe all local regulations regarding the use of radio equipment while operating a vehicle. To safely operate the transceiver in some driving conditions, it may be necessary to pull off the road and park.

Interference With Other Electronic Devices - Most electronic devices are shielded to prevent interference from RF transmitters. However, some devices may be affected, especially when the RF equipment is in close proximity. Therefore, do not use this transceiver where signs prohibit the use of radio equipment, and always request permission before using it near medical devices or equipment. Some automotive anti-lock braking systems (ABS) may also be affected by RF energy.

Interference With Aircraft - Make sure that this transceiver is turned off before entering any aircraft. Federal Aviation Administration (FAA) regulations require that you do not use radio equipment while the aircraft is in the air and that you obtain crew permission before using it on the ground.

FEATURES

General Features

- 16 Zones with 16 Channels per Zone (256 Channels Total)
- Home Zone Select
- Radio-Wide Scan
- Time-Out Timer
- LCD 8-Character Alphanumeric Display with 12 Status Annunciators

Conventional Features

- Channel Scan with User Programmable Scan Lists
- Priority Channel Sampling
- Busy Channel Lockout
- Monitor Mode
- Call Guard Squelch Control
- Penalty Timer
- Conversation Timer
- Repeater Talk-around
- DTMF/ANI Signaling
- User Selectable Power Output

SMARTNET™ II Features

- Group, Enhanced Private Conversation™, Private Conversation II™, and Telephone Calls
- Call Alert™ (Paging)
- Emergency Calls
- Messaging
- Priority Monitor Scanning
- Failsoft Operation
- Dynamic Regrouping

SmartZone® Features

- Site Trunking
- Site Search
- Site Lock/Unlock

TABLE OF CONTENTS

SAFETY INFORMATION	4
OTHER IMPORTANT OPERATING INFORMATION	5
FEATURES	6
General Features	6
Conventional Features	6
SMARTNET™ II Features	6
SmartZone® Features	6
OPTION SWITCH FUNCTIONS	9
CONTROLS AND DISPLAY	11
Top Panel Controls	11
Top Panel Indicators	11
Side Controls	12
Front Panel Keys (3-Key Model)	13
Front Panel Keys (15-Key Model)	14
Display	15
GENERAL OPERATION	16
Introduction	16
Turning Power On and Setting Volume	16
Backlight	17
Option Switches	17
Keypad Lock	18
Low Battery Indication	18
Channel and Zone Selection	18
Home Zone	19
Time-Out Timer	19
Tone Enable/Disable	20
Scanning	20
Conventional and SMARTNET/SmartZone Operation	23
CONVENTIONAL FEATURES	25
Introduction	25
Display Mode Selection	25
Monitoring Before Transmitting	25
Monitor Mode	26
Busy Channel Lockout	27
Call Guard Squelch	27
Penalty Timer	28

TABLE OF CONTENTS

Conversation Timer	29
Repeater Talk-Around	29
Power Output Select	29
Conventional Mode Scanning	30
Priority Channel Sampling	32
Standard Conventional Calls	33
DTMF/ANI Signaling	34
SMARTNET/SMARTZONE FEATURES	34
Introduction	34
Viewing Unit ID	34
Standard Group Calls	35
Enhanced Private Conversation Calls	36
Private Conversation II Calls	39
Telephone Calls	41
Call Alert	44
Messaging	45
Sending Status Conditions	46
Emergency Alarm and Emergency Call	47
Failsoft Operation	47
SMARTNET/SmartZone Scanning	48
Dynamic Regrouping	48
SmartZone Features	49
MISCELLANEOUS	50
Supervisory Tones	50
Rechargeable Battery Pack	52
Dealer Programming	54
Speaking Into Microphone	54
Operation At Extended Range	54
Licensing	54
Transceiver Service	55
INTRINSICALLY SAFE CLASSIFICATION	55
Introduction	55
Classification of Hazardous Areas (Division)	56
Classification of Atmospheres (Class/Group)	56
INDEX	57

OPTION SWITCH FUNCTIONS

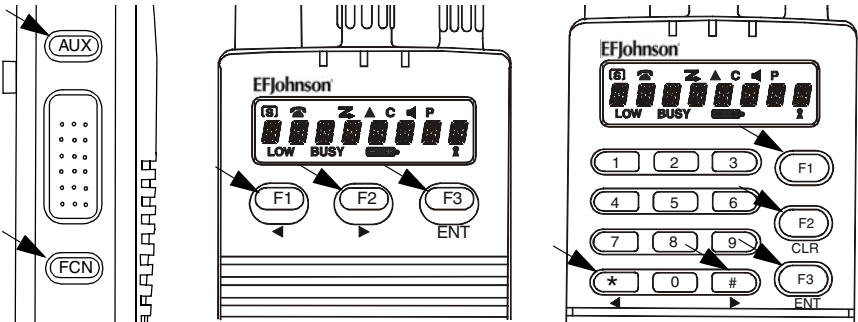

The programmable option switches are AUX and FCN on the side panel and F1/F2/F3 on 3-key models and F1/F2/F3/*/# on 15-key models as shown above. The available functions for each operating mode and the page on which each function is described are listed in the following table. Consult your dealer to determine what functions are controlled by each switch and then write the switch label next to the applicable function. Do this for each mode in which your radio operates. Refer to page 17 for more option switch information.

CONVENTIONAL MODE		
Switch	Function	See Page
	Backlight	17
	Displayed Information	25
	High/Low Power	29
	Home Zone	19
	Keypad Lock	18
	Monitor	26
	Normal/Selective	27
	Priority	32
	Radio Wide Scan	21
	Repeater Talk-Around	29
	Scan	21
	Scan Edit	31
	Tones On-Off	20
	Zone	18

OPTION SWITCH FUNCTIONS

SMARTNET/SMARTZONE MODE		
Switch	Function	See Page
	Backlight	17
	Call Alert	44
	Call Response	41
	Emergency	47
	Home Zone	19
	Keypad Lock	18
	Message	45
	Phone	41
	Private Call	36, 39
	Radio Wide Scan	21
	Scan	21
	Site Lock (SmartZone only)	50
	Site Search (SmartZone only)	49
	Status	46
	Tones On-Off	20
	Zone	18

CONTROLS AND DISPLAY

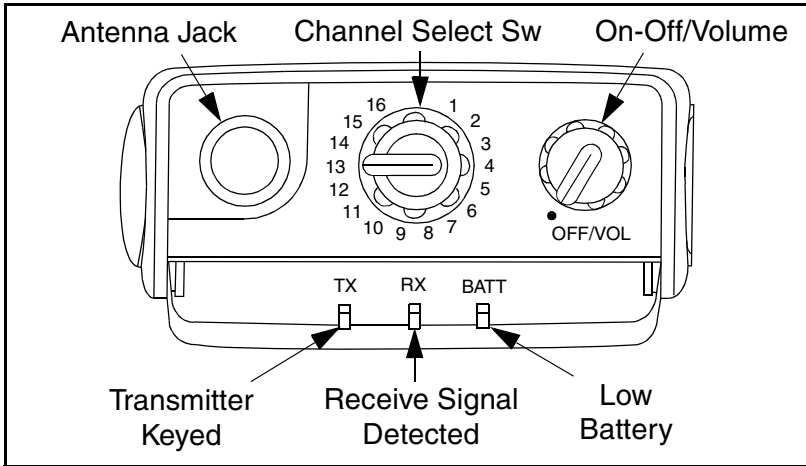

Top Panel Controls

On-Off Volume - Turning this knob clockwise turns power on and sets the volume level. Turning it counterclockwise to the detent turns power off.

Channel Select Switch - Selects up to 16 preprogrammed channels.

Antenna Jack - Connection point for the antenna.

Top Panel Indicators

TX Indicator (Red) - Indicates when the transmitter is keyed.

RX Indicator (Green) Indicates that the channel may be busy because a signal is being detected.

Low-Battery Indicator (Amber) - Indicates that the battery charge is getting low and a recharge will soon be required.

Side Controls

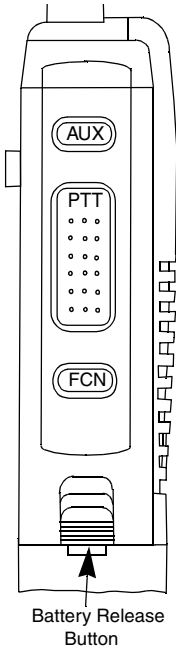

AUX (Auxiliary) - This is a dealer programmable switch that can control various functions (see page 9). With the limited keypad (3-key) version, it is also the CLR key.

PTT (Push-To-Talk) - This switch is pressed to turn the transmitter on. The red TX indicator on the top panel lights when the transmitter is on.

FCN (Function) - This is a dealer programmable switch that can control various functions (see page 9).

Battery Release Button - Pushing this spring-loaded button upward releases the battery so that it can be removed for recharging or replacement. Turn power off before removing the battery.

Accessory Connector (not shown) - This connector is on the opposite side of the transceiver, and it is the connection point for optional accessories such as a speaker-microphone.

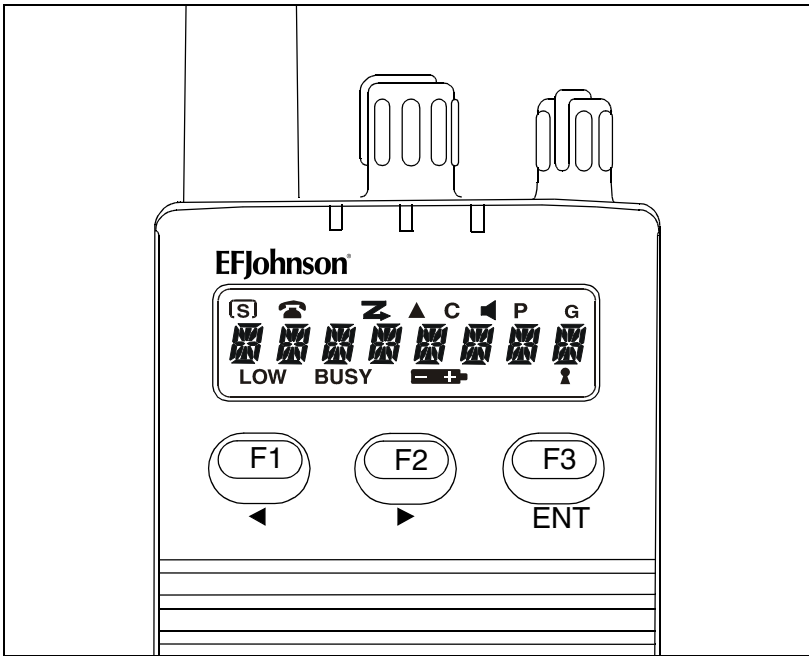

Front Panel Keys (3-Key Model)

F1, F2, F3 - Each of these keys can be programmed by your dealer to control a specific function (see page 9). These keys are also used in menus to scroll left (◀), scroll right (▶), and for the Enter (**ENT**) function. In addition, the top key on the side (**AUX**) functions as a CLR key in menus.

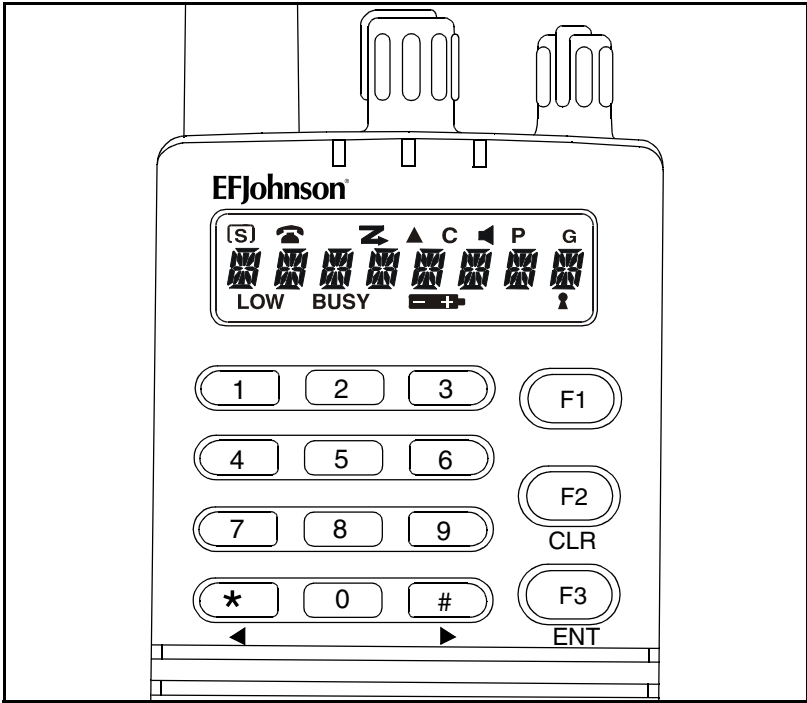

Front Panel Keys (15-Key Model)

0 - 9 - These keys enter a number whenever number entry is required.

F1 - Programmable by your dealer to control a specific function (see page 9).

F2 - Programmable by your dealer to control a specific function. In addition, in menus, it provides the Clear (CLR) function.

F3 - Programmable by your dealer to control a specific function. In addition, in menus, it provides the Enter (ENT) function.

***** - Programmable by your dealer to control a specific function. In addition, in menus, it provides the Scroll Left (◀) function.

- Programmable by your dealer to control a specific function. In addition, in menus, it provides the Scroll Right (▶) function.

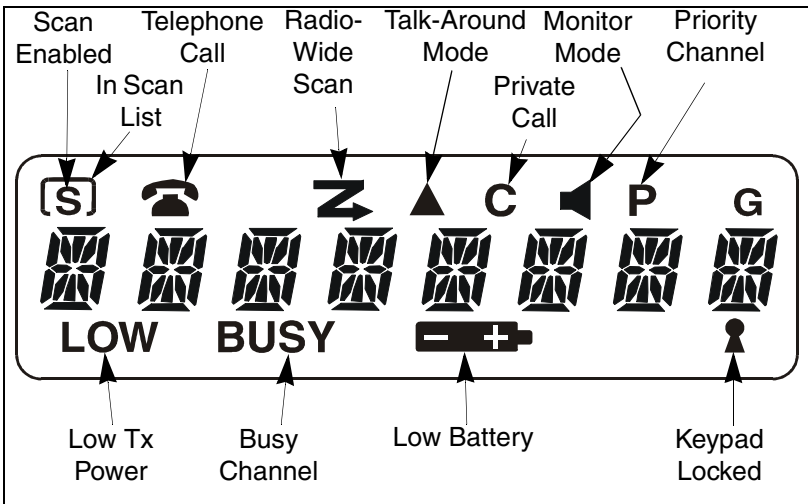



Display

The following information is indicated by the display:

Alphanumeric Display - This eight-character area of the display indicates alphanumeric messages and feature selection information.

S - Indicates that standard scanning is enabled (see page 20). Standard and radio wide scanning cannot be enabled at the same time.

 - The box around the “S” indicates that the current conventional channel is in the standard scan list (page 23).

 - Telephone (interconnect) mode is selected with SMARTNET/SmartZone channels only (page 41).

 - Radio-wide scan is enabled (see page 21).

 - Repeater talk-around is enabled (see page 29).

C - A SMARTNET/SmartZone private call is occurring (pages 36 and 39).



- The conventional monitor mode is enabled (page 26).

P - The selected conventional channel is a priority channel (page 32).

LOW - Low transmit power is selected on a conventional channel (page 29).

BUSY - A busy system or transmit channel is being detected by the Busy Channel Lockout feature (page 27).



- The battery needs recharging (page 18).



- The keypad has been locked by pressing the Keypad Lock option switch (page 18).

GENERAL OPERATION

Introduction

The following section describes features available with both trunked and conventional operation. Features unique to conventional channels are described starting on page 25, and features unique to SMARTNET/SmartZone channels are described starting on page 34.

Turning Power On and Setting Volume

Power is turned on and off by the On-Off/Volume switch on the top panel. When power is initially turned on, an alert tone sounds and the radio software version is momentarily displayed. The zone alias is then displayed followed by the unit ID if a SMARTNET/SmartZone channel is selected (see page 34). The selected channel is then indicated.

To turn power off, turn the On-Off/Volume knob counterclockwise until a click occurs. The display may remain on for a few seconds after power is turned off. It is recommended that power not be turned back on again until the display is blank.

The relative volume level can be determined by noting the position of the index on the On-Off/Volume knob. To enable a reference tone for setting the volume, proceed as follows:

- If key press tones are enabled (see page 20), a short tone sounds when front panel keys are pressed.
- If a conventional channel is selected and the Monitor option switch is programmed (see page 26), pressing that switch unscelches/squelches the receiver and either voice or background noise is heard. If a SMARTNET/SmartZone channel is selected, the receiver cannot be manually unscelched.

Backlight

The backlight for the display and keypad can be manually turned on by pressing the Backlight option switch if it is available. It can also be dealer programmed to automatically turn on when any key is pressed. It then automatically turns off after a programmed delay so that battery drain is minimized.

Option Switches

The programmable option switches are as follows:

- F1, F2, and F3 on front panel. In addition, with full keypad (15-key) models, the *, and # keys are programmable.
- AUX and FCN on the side panel

If your radio is programmed with both conventional and SMARTNET/SmartZone channels (see page 23), these option switches can be dealer programmed to control a different set of functions for each channel type. For example, the F1 switch could select Hi/Lo Power when a conventional channel is selected and Private Calls when a SMARTNET/SmartZone channel is selected. The available functions in each mode are indicated in the tables on pages 9 and 10. If the programmed functions are not indicated in these tables, consult your

dealer to determine how your switches have been programmed. If no option switch has been programmed to control a particular function, that function may not be available or may be in a fixed mode.

Keypad Lock

If the Keypad Lock option switch has been programmed, the keypad can be locked (disabled) to prevent keys from being accidentally pressed. To lock the keypad, press this switch and a locked keypad is indicated by the  icon in the display. To unlock the keypad again, press and hold the Keypad Lock switch until a tone sounds. The keypad can also be disabled by dealer programming. It is then permanently disabled and cannot be re-enabled by the user.

Low Battery Indication

When the battery voltage falls below a preset level, the  icon appears in the display and stays on until power is turned off. In addition, the following low battery indications may be programmed to occur:

- The amber BATT indicator on the top panel lights.
- A beep sounds once per minute in the standby mode.
- A beep sounds each time the PTT switch is pressed.

The battery should be recharged as soon as practical after a low battery indication appears. Refer to page 52 for more information. There is also a battery saver function that may be programmed which automatically switches to a lower power output level when the site is very near.

Channel and Zone Selection

Channel Select

To change the current channel, rotate the 16-position channel selector knob on the top panel to the desired position. With SMARTNET/SmartZone channels, the channel is always indicated by alias (name). With conventional channels, the channel number or frequency may also be displayed (see “Display Mode Selection” on page 25).

Zone Select

A zone is a group of up to any 16 conventional and SMARTNET/SmartZone channels defined by dealer programming. Up to 16 zones can be programmed for a total of 16 x 16 or 256 channels. One use of zones may be to select groups of channels programmed for operation in different geographical areas or radio systems. If selectable zones have been programmed in your radio, consult your dealer for more information on how they are used. Zones are selected as follows:

1. Press the Zone option switch and the alias (name) of the current zone is flashed in the display.
2. Use the number keys to enter the desired zone number or scroll through the available zones using the ◀ and ▶ keys.
3. Once the desired zone is displayed, press the ENT key or wait 4 seconds.

Home Zone

The radio can be programmed with a home zone. Then when power is turned on, the radio can be programmed so that either the home or last selected zone is automatically selected.

If the Home Zone option switch is programmed, it can be used to quickly select or change the home zone. To select the home zone, simply press this switch. Then to change the home zone to the currently selected zone, press and hold this switch until a tone sounds (approximately 1 second).

Time-Out Timer

The time-out timer disables the transmitter if it is keyed for longer than the programmed time. On each channel it can be programmed for times from 15 seconds up to 3 minutes, 45 seconds or disabled (not used). If the transmitter is keyed continuously for longer than the programmed

time, the transmitter is disabled and an invalid condition tone sounds. Five seconds before time-out occurs, an alert tone sounds to indicate that time-out is approaching. The timer and tone are reset by releasing the PTT switch.

One use of this feature is to prevent a channel from being kept busy for an extended period by an accidentally keyed transmitter. It can also prevent possible transmitter damage caused by transmitting for an excessively long period. Conventional channels can also be programmed with the Penalty and Conversation timers that are described starting on page 28.

Tone Enable/Disable

The supervisory tones (see page 50) can be enabled and disabled by the Tones On-Off option switch if it is programmed. When tones are enabled by this switch, “TONE ON” is momentarily displayed and a tone sounds. Conversely, when tones are disabled, “TONE OFF” is displayed and no tone sounds. If the Tones On-Off option switch is not programmed, tones are fixed in the on or off mode.

Scanning

Introduction

Scanning cycles through a list of channels, called a “scan list”, checking each for messages. When a message is detected that your transceiver is programmed to receive, scanning stops and the message is received. Shortly after the message is complete, scanning resumes (unless it has been disabled).

There are two basic scan modes: Standard and Radio Wide. The Standard mode is unique to the type of channel selected (conventional or SMARTNET/SmartZone), and the Radio Wide mode is the same regardless of the channel type selected. Only one of these scan modes can be enabled at a time. Therefore, if standard scanning is enabled while radio

wide scanning is occurring, radio wide scanning is automatically disabled and vice versa. More information on these modes follows.

Standard Scanning

Standard scanning monitors only channels that are the same type as that currently selected. Therefore, if a conventional channel is selected, only conventional channels are scanned, and if a SMARTNET channel is selected, only SMARTNET channels are scanned. Standard scanning is turned on and off by the Scan option switch as follows. If this switch is not programmed, standard scanning is not available.

- To turn standard scanning on, press the Scan option switch. Scanning is enabled when the “**S**” icon is indicated in the upper left corner of the display and SCAN x (conventional) or SCAN ON (SMARTNET/SmartZone) is briefly displayed. The “x” is the number of the conventional scan list (1, 2, or 3) that is selected. Refer to page 30 for more information.
- To turn scanning off, press the Scan option switch again. The “**S**” icon is then no longer indicated and “SCAN OFF” is briefly displayed.
- If the zone or channel is changed while scanning is selected, scanning continues on the same or a different scan list (see scan list information which follows).

Radio Wide Scanning

Radio wide scanning monitors the channels in the preprogrammed radio wide scan list (see page 22). This list may contain up to 16 channels of any type (conventional or SMARTNET/SmartZone) assigned to any zone. Radio wide scanning is turned on and off by the Radio Wide Scan option switch as follows. If this switch is not programmed, radio wide scanning is not available.

- To turn radio wide scanning on, press the Radio Wide Scan option switch. The  icon is then displayed continuously and “RWS ON” is displayed briefly.

- To turn radio wide scanning off, press the Radio Wide Scan option switch again. The  icon is then no longer indicated and “RWS OFF” is displayed briefly.
- If the zone or channel is changed while radio wide scanning, scanning continues normally.

Scan Resume Delay

When a message is received or transmitted while scanning, there is a dealer programmable delay before scanning resumes. The delay after receiving a call prevents another message from being received before you can make a response, and the delay after transmitting a call ensures that you hear a response to your call instead of another message occurring on some other channel.

Standard Mode Scan List

NOTE: The selected channel is always scanned.

With conventional operation up to three scan lists can be programmed. The list that is scanned is selected by the Scan option switch as described on page 30. Selecting another conventional channel does not change the current scan list. The scan lists are user programmable if the Scan Edit option switch is programmed.

With SMARTNET/SmartZone operation, each channel can be programmed so that one of up to three different scan lists is automatically selected or scanning is disabled. The scan list is not user selectable or programmable.

Radio Wide Mode Scan List

With radio wide scanning, there is only one preprogrammed scan list available regardless of the type of channel selected, and it is not user programmable.

Determining Which Channels are in Scan List

Channels in the standard SMARTNET/SmartZone and radio wide lists are not indicated. With conventional channels, the selected channel is in the current scan list if the box  icon (around “S”) is indicated in the upper left corner of the display.

Nuisance Channel Delete

With standard scanning, channels can be temporarily deleted from the scan list, for example, if messages on a channel become annoying. This feature is not available with radio wide scanning. Proceed as follows:

NOTE: The selected channel and conventional priority channels cannot be deleted from the scan list.

1. While receiving a message on the channel to be deleted, press and hold the Scan option switch until the alert tone sounds (about 1 second).
2. The channel is then deleted and scanning of the remaining channels in the scan list resumes.
3. Deleted channels are added back into the scan list if either of the following occur:
 - Scanning is turned off and then on again using the Scan switch.
 - Transceiver power is turned off and then on again.

Conventional and SMARTNET/SmartZone Operation

Introduction

Each selectable channel is dealer programmable for either conventional or SMARTNET™/SmartZone® (trunked) operation. For example, Zone 1/Channel 1 could be a conventional channel, Zone 1/Channel 2 a SMARTNET/SmartZone channel, and so on. Consult your dealer to determine the type or types of operation programmed in your radio. More information on these modes follows.

Conventional Operation

This is a non-trunked operation mode which accesses independent radio channels (there is no automatic access to several channels as with trunked operation). Monitoring before transmitting may not occur automatically in this mode, so you may have to manually monitor the channel before transmitting to make sure that it is not being used by anyone else (see page 25). Selecting a conventional channel selects a transmit and receive frequency and other parameters such as Call Guard squelch coding.

SMARTNET/SmartZone Operation

This is a trunked operating mode that uses ID codes to select which mobiles are being called and which calls are received. Monitoring is performed automatically and special messages and tones indicate busy and out-of-range conditions. Enhanced features include roaming (SmartZone only), telephone, private, and emergency calls, Call Alert, and messaging. Operating features unique to SMARTNET/SmartZone channels are described starting on page 34.

This radio supports only the SMARTNET II trunking protocol. It does not support the SMARTNET I (also referred to as Type I) protocol. When a SMARTNET or SmartZone channel is selected or the radio is powered up on one of those channels, it searches for a control channel and attempts to register on the radio system. Once a control channel is found, the alias (name) of the selected channel is displayed. If a control channel could not be found (because of an out of range condition or the system ID is not correct, for example), “NO SYS” is displayed and the radio continues to search for a control channel.

The control channel transmits and receives system information to and from all radios registered on the system. Therefore, once a control channel is found, it is continuously monitored for incoming call information and is used to make call requests. The radio automatically changes to a traffic channel to place and receive calls and then returns to the control channel when the call is complete.

CONVENTIONAL FEATURES

Introduction

The following information describes features unique to the conventional operating mode (see brief description on preceding page). Refer to the preceding “General Operation” section for information on features common to all operating modes, and to the SMARTNET/SmartZone section starting page 34 for information on features unique to that mode.

Display Mode Selection

If the Displayed Information option switch is programmed, the display mode used to indicate conventional channels can be user selected. Pressing this switch cycles between the following modes. The selected mode does not change when power is turned off. If the Displayed Information option switch is not programmed, the Alias mode is always used.

Alias - The preprogrammed alphanumeric tag for the channel is displayed.

Number - The channel number from 1-16 is displayed.

Frequency - The receive frequency of the selected channel is displayed in megahertz.

Monitoring Before Transmitting

With conventional operation, you may need to manually monitor the channel before transmitting to make sure that it is not being used by someone else. If you were to transmit while someone else was using the channel, you would probably disrupt their conversation. Channels are monitored automatically or manually as follows:

Automatic Channel Monitoring

If the selected channel is programmed for Busy Channel Lockout feature (consult your dealer), monitoring is performed automatically. Refer to the description of this feature on page 27 for more information.

Manual Channel Monitoring

The automatic monitoring just described may not be programmed or it may occasionally disable the transmitter even if the channel is not in use. In this case, the channel must be monitored manually as follows:

Rx Indicator - With scanning disabled, note if the green RX indicator on the top panel is on. If it is not, the channel is not being used and you can transmit your call. If it is on, the channel may be busy and you should not place your call (see next paragraph).

Monitor Mode - There may be times when the busy indication is displayed even though no one is using the channel. Monitoring should then be performed by disabling Call Guard squelch using the Normal/Selective option switch as described on page 28 or the monitor mode described next.

Monitor Mode

The monitor mode temporarily disables squelch control features (such as Call Guard® squelch) so that all messages are heard on the selected channel. It also overrides the Busy Channel Lockout feature (see next section) and temporarily halts scanning.

To monitor the selected transmit channel, select the monitor mode by briefly pressing the Monitor option switch (if available). The  icon is displayed and the receiver unsquelches when the monitor mode is enabled. To disable the monitor mode and return to normal operation, press the Monitor switch a second time.

To monitor the selected receive channel instead of the transmit channel, press and hold the Monitor switch until the alert tone sounds

(approximately 1 second). This function may be useful, for example, during weak signal conditions if intermittent squelching makes a message difficult to understand.

Busy Channel Lockout

The Busy Channel Lockout feature (also called Transmit Disable On Busy) automatically disables the transmitter if the channel is busy when the PTT switch is pressed. When a busy condition is detected by this feature, the transmitter is disabled, “BUSY” is indicated in the lower part of the display, and a tone similar to a standard telephone busy tone sounds until the PTT switch is released. This feature is programmed to operate in one of the following modes on each channel:

Off - The transmitter keys even if the channel is busy.

Noise - The transmitter is disabled if any signal is detected on the channel.

Tone - The transmitter is disabled if the detected squelch coding is not correct.

If busy override is permitted by programming, it is possible to transmit even when the transmitter is disabled by this feature. Simply release the PTT switch and then quickly press it again.

Call Guard Squelch

General

Call Guard® squelch (also called CTCSS/DCS signaling) may be programmed on conventional channels. This feature eliminates distracting messages intended for others using the channel by using a subaudible tone or digital code to control the squelch. This tone or code is unique to a user or talk group on that channel. It is transmitted by the mobile placing a call, and if Call Guard squelch is programmed in the mobile receiving the call, it must detect the correct tone or code to receive the call.

Call Guard Squelch Enable/Disable

To disable Call Guard (Selective) squelch so that all messages on the selected or scanned channels are heard, press the Normal/Selective option switch if programmed. Then to re-enable Call Guard squelch, press the Normal/Selective switch again.

When Call Guard squelch is disabled by this switch, “SQ NORM” is flashed on the lower line of the display, and when it is enabled, “SQ SLCT” is flashed. The mode selected by this switch does not change when other channels are selected or power is cycled. Call Guard squelch can also be disabled by the monitor mode described on page 26.

Changing the Call Guard Code

If you have the full keypad (15-key) model and the ability to change Call Guard codes has been enabled by programming, the transmit and receive codes from one channel can be temporarily or permanently re-assigned to all channels of the current zone. Proceed as follows:

1. Using the number keys, enter the number of the channel that is programmed with the code you want to reassign to all channels (only channels 1-9 can be selected). See “Display Mode Selection” on page 25 for information on displaying channel numbers.
2. The display then briefly indicates “CODE x”, where “x” is the key you pressed. The codes assigned to that channel are then reassigned to all the other channels in the current zone. The reassignments remain in effect even after power is cycled.
3. To restore all Call Guard codes in the current zone to the original settings, press the “0” key.

Penalty Timer

A penalty timer may be programmed on conventional channels to prevent transmissions for a period of time after the time-out timer described on page 19 disables the transmitter. The penalty timer starts

when the PTT switch is released after the transmitter has been disabled. If the PTT switch is pressed during the penalty time, the time-out indication occurs again. A beep sounds when the penalty timer expires and the transmitter can then be keyed.

Conversation Timer

A conversation timer can be programmed on conventional channels to limit the total length of a conversation rather than just the length of each transmission as with the time-out timer. This timer is reset when the time between transmissions exceeds the penalty time just described. A warning tone sounds 5 seconds before the conversation timer expires. When it expires, the transmitter is disabled and a warning tone sounds. The transmitter remains disabled for the length of the penalty time, and a beep sounds when it can be keyed again.

Repeater Talk-Around

Normally, all your transmissions go through a repeater which usually increases range. However, if you are out of range of the repeater, you cannot talk to anyone else on that channel even though the mobile you are calling may be only a short distance away. To allow communication when this situation occurs, repeater talk-around can be used to allow direct communication with a mobile without going through a repeater.

Repeater talk-around can be selected if the Repeater Talk-Around option switch is programmed. When talk-around is enabled by this switch, the ▲ icon is displayed and “RTA ON” is flashed in the display. Then when it is disabled by pressing the switch again, that icon is no longer displayed and “RTA OFF” is flashed. Changing channels or turning power off does not change the selected talk-around mode.

Power Output Select

If the High/Low Power option switch is programmed and power selection is permitted on the current channel, either high or low transmitter power can be selected. Generally, the high power setting allows you to transmit longer distances but uses more battery power, and the

opposite occurs with the low power setting. When the low power is selected on the current channel, “LOW” is indicated continuously near the bottom of the display.

Pressing the High/Low Power switch toggles the power setting. The new level is flashed in the display when this switch is pressed as “HI POWER” or “LO POWER”. If power selection is not permitted on the channel, the fixed power level is flashed and no power change occurs. Turning power off or changing channels does not change the power setting selected for a channel.

Conventional Mode Scanning

General

The following information describes scanning features unique to conventional operation. Scan operation common to all modes is described starting on page 20, and scan operation unique to SMARTNET/SmartZone operation is described starting on page 48.

Selecting a Scan List



When standard scanning with full keypad (15-key) models, one of up to three scan lists can be selected. These lists can be dealer or user programmed as described in the information which follows. With limited keypad (3-key) models, only one scan list is available and it cannot be user programmed. However, nuisance channels can still be temporarily deleted as described on page 23.

Proceed as follows to select a scan list with full keypad models:

1. Press the Scan option switch to enable scanning. The currently selected scan list is momentarily indicated as “Scan x”, where “x” is the list number (1-3).
2. To select one of the other lists, press the number key corresponding to the desired list (1-3) and the selected list is then momentarily displayed as “Scan x”. The selected scan list is stored in memory and does not change until this procedure is repeated.

Programming a Scan List

When full keypad (15-key) models, each of the three scan lists is user programmable if the Scan Edit option switch is programmed and user programming of the list is allowed. Scan list programming is not available with limited keypad (3-key) models. Proceed as follows to program a scan list:

1. Make sure all scanning is off (neither the standard scan “**S**” icon or radio-wide scan  icon displayed).
2. Press the Scan Edit option switch and then within 2 seconds press the number key (1-3) corresponding to the scan list you want to edit. If a list is not selected within the allotted time, the last active conventional standard scan list is automatically selected. The selected list is indicated as “SCAN x”. If user programming is disabled on a list, “NO LIST” is momentarily displayed and it cannot be edited.
3. Select the channel you want to add or delete using the ◀ and ▶ keys. To change zones, press the F1 key and select the new zone.
4. If the selected channel is in the scan list, the box  around “**S**” is indicated in the upper left corner of the display. To add the channel to the scan list, press the “1” key, and to delete the channel, press the “2” key.

NOTE: The priority channel cannot be deleted (see “Priority Channel Sampling” description which follows).

5. To exit this mode and save the changes, press the ENT or CLR key.

Transmitting in Scan Mode

When the transmitter is keyed with scanning enabled, the radio can be programmed so that the transmission always occurs on one of the following channels:

- Priority channel (see following description)
- Selected channel
- Channel of a call if the response is made before scanning resumes

Priority Channel Sampling

General

The priority channel sampling feature ensures that when standard scanning, messages on the priority channel are not missed while listening to a message on some other channel. Your transceiver can be programmed so that the priority channel is a fixed channel associated with the current scan list, the currently selected channel, or not used. When the selected channel is a priority channel, “**P**” is indicated in the upper right part of the display.

Priority channel sampling occurs only with Standard conventional scanning. It does not occur with Radio Wide scanning, when listening to any type of SMARTNET/SmartZone call, or when transmitting. A series of “ticks” may be heard when the priority channel is sampled while listening to a message on some other channel.

Changing The Priority Channel

If a specific priority channel is associated with the current scan list, it can be changed if the Priority option switch is programmed. Proceed as follows:

1. Make sure all scanning is off (neither the standard scan “**S**” icon or radio-wide scan  icon displayed).
2. Select the channel that you want to be the priority channel using the channel selector switch on the top panel. If the channel is in a different zone, also select the appropriate zone.
3. Press the Priority option switch and the “**P**” icon is displayed to indicate that the selected channel is now the priority channel.

Standard Conventional Calls

Standard conventional calls are calls to or from other mobile units on the selected channel. The proper coded Call Guard signaling (see page 27) may need to be transmitted for them to receive your call and also for you to receive their calls. Proceed as follows to place and receive these calls:

Placing a Standard Conventional Call

1. Turn power on and set the volume as described on page 16. Select the channel programmed for the mobile you want to call (see “Channel and Zone Selection” on page 18).
2. Monitor the channel automatically or manually as described on page 25.
3. Press the PTT switch and the call proceeds as follows:
 - If the Busy Channel Lockout feature is programmed on the channel, the transmitter is automatically disabled if the channel is busy (see description on page 27).
 - Otherwise, busy and out-of-range conditions are not indicated and speaking can begin after monitoring the channel.
4. Press (and hold) the PTT switch to talk and release it to listen.

Receiving a Standard Conventional Call

1. Select or scan the channel programmed for the call you want to receive (refer to pages 20 and 30 for more scanning information).
2. When the call is received, press the PTT switch to talk and release it to listen. If scanning, you may have to respond before scanning resumes to ensure that the response occurs on the channel of the call.

DTMF/ANI Signaling

DTMF (Dual Tone Multi-Frequency) tones can be generated manually or automatically for ANI (Automatic Number Identification) and other purposes. The following options may be enabled by dealer programming for each conventional channel:

DTMF Keypad - Pressing 0-9, *, or # on the keypad while holding the PTT switch transmits the corresponding tone until the key is released.

Pre-Tx ANI - A preprogrammed ANI sequence is automatically sent when you press the PTT switch.

Post-TX ANI - A preprogrammed ANI sequence is automatically sent each time you release the PTT switch.

Disabled - All DTMF signaling is disabled.

SMARTNET/SMARTZONE FEATURES

Introduction

The following information describes features unique to the SMARTNET and SmartZone operating mode (see brief description on page 23). Refer to the preceding “Conventional Features” section for information on features common to all operating modes, and to the “General Information” section starting on page 16 for information on features common to all operating modes.

Viewing Unit ID

Each radio in a SMARTNET system is identified with a system ID and Unit ID. To display the Unit ID, make sure that a SMARTNET channel is selected and then turn power off and then on again. The software version number, current zone, and Unit ID are then displayed in sequence. The six-digit Unit ID is displayed as IDxxxxxx.

Standard Group Calls

Standard group calls are between you and another mobile, group of mobiles, or a control station (a radio at a fixed location). Most calls you make will probably be this type.

Placing a Standard Group Call

1. Turn power on and set the volume as described on page 16. Select the channel programmed for the talk group you want to call (see page 18). A regular or announcement talk group can be selected.
2. Press the PTT switch and when the alert tone sounds, begin talking. Other indications that may occur are as follows:
 - If the busy tone sounds and “BUSY” is displayed, the system is busy. Release the PTT switch and wait for the call back tone to sound. Then press the PTT switch within 3 seconds and begin talking.
 - If a continuous tone sounds while pressing the PTT switch, you may be out-of-range. Drive closer or away from shielding objects and try again.
 - If your unit ID is invalid, the call is being made to an invalid group ID, or group calls are not allowed, “INVALID ID” is displayed and an alert tone sounds.

Receiving a Standard Call

Group calls are automatically received if a SMARTNET/SmartZone channel is selected. The display continues to indicate the selected channel tag (alias) when a call is received.

Enhanced Private Conversation Calls

General

Private calls allow you to place a call to a specific mobile unit. Either the Enhanced Private Conversation™ or Private Conversation II™ modes may be programmed depending on the capabilities of the radio system. The Enhanced Private Conversation mode is described in the following information, and the Private Conversation II mode is described starting on page 39.

The Private Call option switch is required to place these calls, and either that switch or the Call Response option switch is required to receive them. Proceed as follows.

Placing an Enhanced Private Conversation Call

This call can be initiated by selecting the unit ID from a call list (list entry) or by directly entering it using the keypad (direct entry). Direct entry is available with full keypad (15-key) models only. Proceed as follows:

List Entry Method

1. With a SMARTNET/SmartZone channel selected, momentarily press the Private Call option switch. The private call mode is indicated by “C” in the upper part of the display. The tag (alias) of the last ID called is displayed if it matches an ID in your call list. Otherwise, the last ID called is displayed.
2. Enter the index of the desired ID if you know it or scroll through the list using the ◀ and ▶ keys until you find the desired ID. Press the **CLR** key to cancel the call.
3. Press the PTT switch or the **ENT** key to initiate the call. The display then indicates the alias of the destination radio. Proceed to the bulleted list following the next method for conditions that may occur next.

Direct Entry Method (Full Keypad Models Only)

1. With a SMARTNET/SmartZone channel selected, press and hold the Private Call option switch until a tone sounds (approximately 1 second). The last ID called is displayed, and the private call mode is indicated by “**C**” in the upper part of the display.
2. Using the 0-9 keys, enter the 6-digit ID of the mobile unit you are calling. Press the ◀ key to erase the last digit entered or press the **CLR** key to cancel the call.
3. Press the PTT switch or the **ENT** key to initiate the call. If the entered ID is invalid, “INVALID” is momentarily displayed and the call is not initiated. If the entered ID is valid, the display indicates the alias of the ID if it matches an ID in your call list. Otherwise, the ID you entered continues to be displayed. Any of the following conditions may then occur:
 - If the radio you are calling is on the air, telephone type “ringing” is heard for 20 seconds or until the called party answers.
 - If the called party answers and the call is successful, the person’s voice is heard and the call is carried on the same as a group call. To end the call at any time, press the **CLR** key.
 - If the called party does not answer within 20 seconds, “NO ANSWR” is displayed and a continuous tone sounds. End the call by pressing the **CLR** key.
 - If the called radio is not in service, no ringing is heard, “NO ACK” is displayed, and a continuous tone sounds. End the call by pressing the **CLR** key.
 - If neither your radio nor the radio being called is authorized to make unit-to-unit calls, “REJECT” is displayed and a continuous tone sounds. End the call by pressing the **CLR** key.

- If the called party answers but the radio system is busy, four low tones sound and “BUSY” and “WAIT” are alternately displayed. When the system is no longer busy, the called party automatically responds.
- If an out-of-range condition exists or the radio system is not in service, “LOST CALL” is displayed and a continuous tone sounds. End the call by pressing the **CLR** key.

Receiving an Enhanced Private Conversation Call

These calls are automatically received if a SMARTNET/SmartZone channel is selected. Proceed as follows:

1. When a call is received, a recurring unit call tone (three beeps) sounds for up to 20 seconds, and “CALL RCV” and the current channel alias are alternately displayed.
 2. To answer the call, press the Private Call option switch and then the PTT switch and begin talking. The private call mode is indicated by “**C**” in the upper part of the display. The alias of the incoming call is displayed if the ID is in your call list. Otherwise, the unit ID is displayed. *NOTE: If the Private Call option switch is not pressed before the PTT switch, a group call is transmitted on the selected group.*
- To end the call when the conversation is complete or at any other time, press the **CLR** key.
 - If unit-to-unit (private) calls are not permitted (Private Call switch not programmed), press the Call Response option switch, if available, to answer the call.
 - If the call is not answered within 20 seconds, it is automatically terminated.
 - If the radio system is busy, four low tones sound and “BUSY” and “WAIT” are alternately displayed. When the system is no longer busy,

the call back tone (four beeps) is heard and your radio automatically starts transmitting. Press the PTT switch to continue the call.

- To ignore an incoming call, press the **CLR** key or wait 20 seconds until the recurring unit call tone stops sounding. *NOTE: If the CLR key is programmed for the Call function, it will not clear the call.*

Private Conversation II Calls

General

Private calls allow you to place a call to a specific mobile unit. Either the Enhanced Private Conversation™ or Private Conversation II™ modes may be programmed depending on the capabilities of the radio system. Operation in the Enhanced Private Conversation mode was described starting on page 36, and operation in the Private Conversation II mode is described in the following information.

The Private Call option switch is required to place these calls, and either that switch or the Call Response option switch is required to receive them. Proceed as follows.

Placing a Private Conversation II Call

This call can be initiated by selecting the unit ID from a call list (list entry) or by directly entering it using the keypad (direct entry). Direct entry is available with full keypad (15-key) models only. Proceed as follows:

List Entry Method

1. With a SMARTNET/SmartZone channel selected, momentarily press the Private Call option switch. The private call mode is indicated by “**C**” in the upper part of the display. The tag (alias) of the last ID called is displayed if it matches an ID in your call list. Otherwise, the last ID called is displayed.

2. Enter the index of the desired ID if you know it or scroll through the list using the ◀ and ▶ keys until you find the desired ID. Press the **CLR** key to cancel the call.
3. Press the PTT switch to initiate the call. The display then indicates the alias of the destination radio. Wait approximately 1 second and then begin talking. Proceed to the bulleted list which follows the next method for conditions that may then occur.

Direct Entry Method (Full Keypad Models Only)

1. With a SMARTNET/SmartZone channel selected, press and hold the Private Call option switch until a tone sounds (approximately 1 second). The last ID called is displayed and the private call mode is indicated by “**C**” in the upper part of the display.
2. Using the 0-9 keys, enter the 6-digit ID of the unit you are calling. Press the ◀ key to erase the last digit entered or press the **CLR** key to cancel the call.
3. Press the PTT switch to initiate the call. If the entered ID is invalid, “INVALID” is momentarily displayed and the call is not initiated. If the entered ID is valid, the display indicates the alias of the ID if it matches an ID in your call list. Otherwise, the ID you entered continues to be displayed. Wait approximately 1 second and then begin talking. Any of the following conditions may then occur.
 - If the called party answers and the call is successful, the person’s voice is heard and the call is carried on the same as a group call. To end the call at any time, press the **CLR** key.
 - If the radio system is busy, four low tones sound and the “BUSY” and “WAIT” are alternately displayed. When the system is no longer busy, the call back tone (four beeps) is heard and a channel is automatically acquired. Press the PTT switch to continue the call.

Receiving a Private Conversation II Call

Unit-to-unit calls are automatically received if a SMARTNET/SmartZone channel is selected. Proceed as follows:

1. When a call is received, an alert tone sounds and the caller's voice is heard. While voice is heard, "C" is indicated in the upper part of the display and "CALL RCV" and the current channel alias are alternately displayed.
2. To answer the call, press the Private Call option switch and then the PTT switch and begin talking. The private call mode is indicated by "C" in the upper part of the display. The alias of the incoming call is displayed if the ID is in your call list. Otherwise, the unit ID is displayed. *NOTE: If the Private Call option switch is not pressed before the PTT switch, a group call is transmitted on the selected group.*
 - To end the call when the conversation is complete or at any other time, press the **CLR** key. If the call is not answered within 20 seconds, it is automatically terminated.
 - If private calls are not permitted (Private Call switch not programmed), press the Call Response option switch, if available, to answer the call.

Telephone Calls

General

Telephone calls allow you to place and receive calls over the public telephone system using your transceiver. If your transceiver is programmed for telephone calls (Phone option switch programmed), they are placed and received as follows:

Placing a Telephone Call

Telephone calls can be placed by selecting the number from a preprogrammed phone number list (list entry) or by directly entering it using the keypad (direct entry). Direct entry is available with full keypad (15-key) models only. Proceed as follows:

List Entry Method

1. With a SMARTNET/SmartZone channel selected, momentarily press the Phone option switch. The phone mode is indicated by the  icon, and the display indicates the alias of the last called telephone number if it is in your phone number list. Otherwise, the last called telephone number is displayed.
2. Enter the index of the desired telephone number if you know it or scroll through the list using the ◀ and ▶ keys until you find the desired number. Press the **CLR** key to cancel the call.
3. Press the PTT switch or the **ENT** key to initiate the call. The display indicates “WAIT” while the connection to the phone system is occurring. Once connected, the normal dial tone is heard and the alias of the number being called is displayed. The radio then automatically dials the telephone number and the normal ringing or busy tone is heard. Proceed to the bulleted list which follows the next method for conditions that may then occur.

Direct Entry Method (Full Keypad Models Only)

1. With a SMARTNET/SmartZone channel selected, press and hold the Phone option switch until a tone sounds (approximately 1 second). The last phone number called is displayed, and the phone mode is indicated by the  icon.
2. Enter the number using the **0-9** and **#** keys. To dial a ***** character, press F1 and then the ***** key. To enter a pause (indicated by “P”), press the F1, *****, and then **#** keys. The number scrolls to the left in the display so that the seven right-most digits are always displayed. Numbers up to 16 digits (including pauses) can be entered. Press the **CLR** key to cancel the call.
3. Press the PTT switch or the **ENT** key to initiate the call. The display indicates “WAIT” while the connection to the phone system is occurring. Once connected, the normal dial tone is heard and the alias of the number being called is displayed. The radio then automatically dials the

telephone number and the normal ringing or busy tone is heard. Any of the following conditions may then occur.

- After the called party answers, press the PTT switch to talk and release it to listen. You cannot talk and listen at the same time because the radio cannot transmit and receive at the same time. Each time the PTT switch is released, a tone is heard by the other party that indicates when a response can be made. To end the call when the conversation is complete or at any other time, press the **CLR** key.
- If enabled by dealer programming, a number can be dialed during a call by simply holding down the PTT switch and dialing the number.
- If an out-of-range condition exists or the radio system is not in service, “LOST CALL” is displayed and a continuous tone sounds. End the call by pressing the **CLR** key.
- If you are not authorized to make telephone calls, “REJECT” is displayed and a continuous tone sounds. End the call by pressing the **CLR** key.
- If the radio system is busy, “BUSY” is displayed and a busy tone sounds. The call automatically proceeds when the radio system becomes available. If the call is ended before it proceeds, your position in queue is lost.

Answering a Telephone Call

Telephone calls are automatically received if a SMARTNET/SmartZone channel is selected. Proceed as follows:

1. When a telephone call is received, “ringing” similar to a standard telephone is heard. The display alternately indicates “PHONE” and the current channel alias.
2. To answer the call, press the Phone option switch and the phone mode is indicated by the  icon. Press the PTT switch to talk and release it to listen.

3. To end the call when the conversation is complete or at any other time, press the **CLR** key. Also press the **CLR** key to ignore an incoming call and end it without answering. *NOTE: If the CLR key is programmed for the Phone function, it will not clear the call.*

Call Alert

The Call Alert™ feature allows pages to be sent and received. Proceed as follows:

Sending a Page

Pages can be placed by selecting the unit ID from a preprogrammed list (list entry) or by directly entering it using the keypad (direct entry). Direct entry is available with full keypad (15-key) models only.

List Entry Method

1. With a SMARTNET/SmartZone channel selected, momentarily press the Call Alert option switch. The tag (alias) of the last ID called is displayed if it matches an ID in your call list. Otherwise, the last ID called is displayed.
2. Enter the index of the desired ID if you know it or scroll through the list using the ◀ and ▶ keys until you find the desired ID. Press the **CLR** key to cancel the call.
3. Press the PTT switch or the **ENT** key to send the page. The display then indicates the alias of the radio being paged. Proceed to the bulleted list which follows the next method for conditions that may then occur.

Direct Entry Method (Full Keypad Models Only)

1. With a SMARTNET/SmartZone channel selected, press and hold the Call Alert option switch until a tone sounds (approximately 1 second). The last ID called or paged is displayed.

- Using the **0-9** keys, enter the 6-digit ID of the unit you are calling. Press the **◀** key to erase the last digit entered or press the **CLR** key to cancel the page.
- Press the PTT switch or the **ENT** key to send the page. If the entered ID is invalid, “INVALID” is momentarily displayed and the page is not sent. If the entered ID is valid, the display indicates the alias of the ID if it matches an ID in your call list. Otherwise, the ID you entered continues to be displayed. The page is then sent and any of the following conditions may then occur.
 - If the radio you are paging is on the air and received your page, a signaling success tone (six beeps) sounds and the display momentarily indicates “ACK RCVD”. The alias of the selected channel is then displayed continuously.
 - If the radio you are paging is not in service, a tone sounds and “NO ACK” is displayed. Press the **CLR** key to cancel the page.

Answering a Page

- When a page is received, the display alternately indicates “PAGE RCV” and the alias of the current channel and a recurring received page tone sounds (six beeps) sounds.
- To clear and ignore the page, press the **CLR** key. *NOTE: If the CLR key is programmed for the Private Call function, it will not clear the page.*
- Answering a page is the same as placing a private call. Therefore, press the Private Call option switch and follow the instructions for placing a private call on page 36 or page 39, whichever is applicable.

Messaging

The messaging feature allows preprogrammed messages to be sent to your dispatcher. Up to 16 messages can be preprogrammed, and they are identified by a tag (alias). If a Message option switch is programmed, messages are sent as follows:

1. Momentarily press the Message option switch. The alias of the last message sent is displayed.
2. Enter the index of the desired message if you know it or scroll through the list using the ◀ and ▶ keys until you find the desired message. Press the **CLR** key to cancel the message.
3. Press the PTT switch or the **ENT** key to send the message. When the message is received and acknowledged by the dispatcher, a signaling success tone (six beeps) sounds and the display returns to the normal channel indication. If there is no acknowledgment after 6 seconds, a tone sounds and “NO ACK” is displayed. Press the **CLR** key to return to normal operation.

Sending Status Conditions

The status feature allows you to send your current status to your dispatcher. Up to eight status conditions can be preprogrammed, and they are identified by an alias (name). If the Status option switch is programmed, status conditions are sent as follows:

1. Momentarily press the Status option switch. The alias of the last status sent is displayed.
2. To change the displayed status, enter the index of the desired status if you know it or scroll through the list using the ◀ and ▶ keys until you find the desired status. Press the **CLR** key to cancel this function.
3. Press the PTT switch or the **ENT** key to send the status. When the message is received and acknowledged by the dispatcher, a signaling success tone (six beeps) sounds and the display returns to the normal channel indication. If there is no acknowledgment after 6 seconds, a tone sounds and “NO ACK” is displayed. Press the **CLR** key to return to normal operation.

Emergency Alarm and Emergency Call

Emergency alarms and emergency calls are separate functions that can be individually programmed on SMARTNET/SmartZone channels. The Emergency option switch is required to initiate these features. An emergency alarm is a special data transmission to alert your dispatcher of an emergency situation, and an emergency call is an urgent request for access to a voice channel. The emergency alarm and call are transmitted on the emergency talk group or announcement group that has been preprogrammed by your system operator on the currently selected channel. Proceed as follows to initiate an emergency alarm or call:

1. To transmit an emergency alarm, select a SMARTNET/SmartZone channel that has that feature enabled and then press the Emergency option switch.
2. The emergency alarm is then transmitted and “EMERGENCY” is indicated in the display for a short time. Transmitting continues until an acknowledgment is received (indicated by two beeps) or the programmed number of attempts have occurred. Silent operation may also be programmed in which case no audio or visual indication of the alarm condition occurs.
3. To transmit an emergency call, press the Emergency option switch with a SMARTNET/SmartZone channel selected that has that feature enabled. Then manually press the PTT switch and begin speaking as with a standard call. All calls that follow are then emergency calls and they occur on the emergency talk group.
4. To exit the emergency mode, power must be turned off and then on again.

Failsoft Operation

If a failure occurs in the SMARTNET/SmartZone system so that it cannot be used, the transceiver automatically enters the failsoft mode. When this mode is selected, the display alternately indicates “FAIL-SOFT” and the alias of the selected channel.

When in the failsoft mode, operation is in the conventional mode on a preprogrammed failsoft channel. If a transmission is attempted before a failsoft channel is located, a continuous tone sounds until the PTT switch is released. When the radio system returns to normal operation, this condition is automatically detected and normal operation resumes.

SMARTNET/SmartZone Scanning

Scanning on a SMARTNET/Smartzone channel is similar to the standard and radio wide scanning described starting on page 20. Each channel can be programmed with a different scan list that includes up to 16 channels, one of which can be a priority channel.

Scanning is enabled/disabled by the Scan option switch. In addition, channels can be programmed so that scanning automatically starts whenever the channel is selected. Scanning is temporarily disabled and “**S**” turns off if a channel is selected that has scanning disabled. Then when a channel is selected again that permits scanning, it is automatically re-enabled.

In addition to calls on channels in the scan list, pages, private calls, and telephone calls are received while scanning. Messages on the priority channel are received while listening to lower priority messages. However, private and telephone calls are not interrupted by calls on the priority channel.

Dynamic Regrouping

The dynamic regrouping feature allows a dispatcher to switch users to a dynamically defined channel to receive an important message. Dynamic regrouping operates as follows:

1. When this command is received, the alternating dynamic regrouping tone sounds, the transceiver automatically changes to the regrouping channel, and the display alternately indicates “REGROUP” and the alias of the selected channel. All transmitting and receiving then occurs on this channel.

2. To reset all talk and announcement groups to normal so that only the designated regrouping channel is on the dynamic group, manually select the designated regrouping channel if you know it. If this channel is not selected or there is no designated regrouping channel, all transmissions occur on the dynamically assigned group regardless of which channel is selected, and the regrouping tone sounds each time the PTT switch is pressed.
3. When regrouping is canceled by the dispatcher, transceiver operation returns to normal.

SmartZone Features

Introduction

As described on page 23, the SmartZone® mode provides wide area coverage by allowing roaming between SMARTNET and conventional sites. SmartZone operation is the same as SMARTNET with the following additional features:

Determining Current Site and Searching For New Site

To determine the current radio site, momentarily press the Site Search option switch (if programmed). If currently registered on a site, "SITE x" is displayed, where "x" is the site number. If the site is locked (see following), "LOCK x" is displayed instead. The display then indicates the RSSI (Receive Signal Strength Indicator) value of the current site as "RSSI x". If the Site Search switch is not pressed again, this mode is exited and the normal channel display returns.

To search for a new site, repeatedly press the Site Search option switch while "SITE x", "LOCK x", or "RSSI x" is displayed. Each time it is pressed, information for the next site is displayed. To select the displayed site, simply do not press the switch again and that site is selected when the normal channel display returns. If site lock is on (see next section) the radio will be locked on this site when this function is exited.

Locking/Unlocking a Site

It is sometimes desirable to stay on the current site regardless of signal level. To lock the radio on the current site so that it does not search for another, press the Site Lock option switch (if programmed). The display then momentarily indicates “LOCK x” to indicate that the current site is locked (“x” is the current site number). To unlock the site, press the Lock switch again and “UNLOCK” is momentarily displayed.

When locked on a site, it is still possible to search for a different site using the site search function described in the preceding section. When a new site is found, the radio is then locked on that site.

MISCELLANEOUS

Supervisory Tones

Single Beep (Alert Tone)

- Power was turned on and a successful power-up sequence occurred (see page 16).
- The time-out timer is about to expire or the penalty timer has expired (page 19 and page 28).
- The conversation timer is about to expire (page 29).
- The system received your page but the paged mobile is not on the air (page 44).
- Telephone interconnect is not operational (page 41).

Continuous Tone (Invalid or No Acknowledge Condition)

- A transmission is being attempted on an unprogrammed channel or a conventional channel programmed as receive-only.
- The transmitter is disabled by the busy channel lockout feature (page 27).
- The transmitter has been disabled by the time-out timer feature (page 19).

- The transmitter has been disabled by the conversation timer (page 29).
- An out-of-range condition exists (SMARTNET/SmartZone only).
- A transmission is being attempted before the penalty timer has expired (page 28).
- Dynamic regrouping has been exited but the dynamic regrouping channel is still selected (page 48).
- The paged mobile did not acknowledge the page (page 44).
- The message that was sent has not been acknowledged (page 45).
- The status condition that was sent has not been acknowledged (page 46).

Single Short Medium-Pitch Tone

- A valid key has been pressed.

Single Short Low-Pitch Tone

- An invalid key has been pressed.

Six Beeps (Recurring)

- The page was received (page 44).

Three Beeps (Recurring)

- A unit-to-unit call was received (page 36).

Six Beeps

- The paged radio received the page and acknowledged it (page 44).
- The message that was sent has been received and acknowledged (page 45).
- The status condition that was sent has been received and acknowledged (page 46).

Two Beeps

- The emergency alarm condition was acknowledged (page 47).

Gurgle-Like Tone

- Dynamic regrouping has occurred (page 48).
- Dynamic regrouping has occurred but the regrouping channel is not selected (page 48).

Four Low Tones (Busy Signal)

- The radio system is busy or a busy condition exists when making a telephone call.

Four Alternating High and Low Tones

- A channel is available after a busy condition occurred (SMARTNET/ SmartZone only).

Rechargeable Battery Pack

WARNING

Do not dispose of the battery pack in fire because it may explode. The nickel metal-hydride (NiMH) battery pack used by this radio must be disposed of in accordance with local regulations. Do not short the terminals because the battery may become very hot.

Battery Life

With proper care, the nickel metal-hydride (NiMH) battery pack used by this radio should provide excellent service. When the pack no longer holds a charge or provides only a very short operating time, it must be replaced with a new unit.

Typical operating time before recharging is required is approximately 7.5 hours. This assumes that the transceiver is transmitting at high power 5% of the time, receiving and producing audio 5% of the time, and in the standby mode (receive with audio muted) 90% of the time. If the low-power mode is selected or different times are spent in these modes,

operating time varies accordingly. The charge of the battery and ambient temperature also affect operating time.

NOTE: Be sure to turn transceiver power off before removing the battery pack. Failure to do so may result in the current settings not being saved in memory.

Recharging

Recharging is required when the  icon appears in the lower part of the display. In addition, the amber low-battery indicator on the top panel may light and a tone may sound when this condition initially occurs and whenever the PTT switch is released. Refer to “Low Battery Indication” on page 18 for more information.

The pack can be recharged while still on the transceiver or it can be charged separately. To remove the battery pack from the transceiver, press the spring-loaded release button on the side upward and slide the battery off. A new battery pack must be charged before use.

Battery Care

One cause of shortened battery life is repeated deep discharge. Therefore, it is recommended that the battery be recharged as soon as practical after the low-battery indication appears (see preceding information). Do not continue using the transceiver until the battery is completely discharged. Another cause of reduced battery life is operation at temperature extremes. It is also good practice not to regularly leave a pack in the charger for extended periods after it is completely charged.

It is possible that the pack could develop a characteristic called “memory” although these packs are designed to minimize that problem. When a pack has this problem, it acts as if it is totally discharged even though it has greater capacity. This can be caused by discharging a pack only slightly before recharging, charging at too high a temperature, or extended storage. If a pack develops this problem, it can usually be corrected by performing three discharge/charge cycles.

Dealer Programming

As noted several times in this manual, programming determines the availability and specific operation of many features. This refers to the programming performed by your dealer when the radio was set up, not to any programming that you can perform. If a feature is controlled by a front panel option switch and that switch is not available, it is probably not available or in a fixed condition. Contact your dealer for more information on how programmable functions have been set for your application.

Speaking Into Microphone

For best results, hold the speaker grille about 1-2 inches from your mouth and speak at a normal conversational level. Do not shout since it distorts your voice and does not increase range. Make sure that the PTT (push-to-talk) switch is pressed before you begin to speak and released as soon as the message is complete.

Operation At Extended Range

When approaching the limits of radio range, the other party may not be able to hear your transmissions and there may be an increase in background noise when messages are received. You may still be out of range even though you can hear a message. The reason for this is that the signal you are receiving is usually transmitted at a higher power level than the one transmitted by your transceiver. Communication may be improved by moving to higher ground or away from shielding objects such as tall buildings or hills.

Licensing

A government license is usually required to operate this transceiver on the air. Your dealer will normally handle the licensing requirements.

Transceiver Service

If the transceiver begins operating improperly, try turning power off and then on again to reset the logic. Also make sure that the battery is fully charged and in good condition. If the transceiver still does not operate properly, return it to your dealer for service.

NOTE: There are no user-serviceable components inside this transceiver. Altering internal adjustments can cause illegal emissions, void the warranty, and result in improper operation that can seriously damage the transceiver.

INTRINSICALLY SAFE CLASSIFICATION

Introduction

“Intrinsically Safe” is a fire safety rating given to this transceiver by the Factory Mutual Research Corporation. When equipment is given this rating, it is considered safe to use in certain flammable or combustible atmospheres. Flammable atmospheres have been categorized by Class, Division, and Group as described in the next two sections. The specific hazardous atmospheres in which this transceiver has been approved to operate are as follows. This information is also listed on the label on the back of the transceiver.

Intrinsically Safe - Class I, II, and III, Division 1, Groups C, D, E, F, and G.

Non-Incendive - Class I, Division 2, Groups A, B, C, and D.

Temperature Code - T3C (Battery Pack Part No. 587-8150-136).

Classification of Hazardous Areas (Division)

Hazardous areas are classified as Division 1 or 2 as shown below. Since a Division 1 area is considered most hazardous, a transceiver approved for a specific Division 1 atmosphere can also be used in the same Division 2 atmosphere. The intrinsically safe rating applies to Division 1 areas and the nonincendive rating applies to Division 2 areas.

Class I and II Materials (Gases, Vapors, and Dusts)

Division	Area
1	An area where there is or could be an explosive atmosphere most of the time in normal operations.
2	An area where an explosive atmosphere exists only as a result of a fault (something going wrong).

Class III Materials (Fibers or Flyings)

Division	Area
1	An area in which easily ignitable fibers or materials producing combustible flyings are handled, manufactured, or used.
2	An area in which easily ignitable fibers are stored or handled. An exception is in process of manufacture.

Classification of Atmospheres (Class/Group)

For the purposes of testing and approval, various atmospheric mixtures have been grouped on the basis of their hazardous characteristics. Equipment is approved for a class of material and also for the specific group of gas, vapor, or dust in that class. Class I materials include gases and vapors, Class II materials include combustible dusts, and Class III materials include ignitable fibers or flyings. The typical hazardous materials in each group and class are shown in the following table.

Typical Hazard	Group	Class
Acetylene	A	I
Hydrogen	B	I
Ethylene, ethyl ether, cyclopropane	C	I
Gasoline, naphtha, butane, propane, alcohol, acetone, benzol, natural gas	D	I
Metal dust including aluminum, magnesium, and their alloys	E	II
Carbon black, coal or coke dust	F	II
Flour, starch, or grain dusts	G	II
Ignitable fibers/flyings such as rayon and cotton	-	III

INDEX

A

Accessory Connector 12
 Alias 18
 ANI Signaling 34
 Antenna Jack 11
 Atmosphere Classifications 56
 AUX Switch 12, 17

B

Backlight 17
 BAT Indicator 11
 Battery
 Care 53
 Life 52
 Recharging 53
 Battery Release Button 12
 Busy Channel Lockout 26, 27, 33
 Busy Indicator 26

C

Call Alert (Paging) 44
 Call Guard Squelch 27
 Changing Code 28
 Disabling 28
 Channel Frequency 25
 Channel Number 25
 Channel Select 18
 Channel Select Switch 11
 Class/Group Classifications 56
 Clear Key 12, 14
 Control Channel 24
 Conventional Mode 23
 Conversation Timer 29
 CTCSS Signaling 27

D

DCS Signaling 27
 Display 15

Display Mode Select 25
Division Classifications 56
DTMF/ANI Signaling 34
Dynamic Regrouping 48

E

Emergency Alarms 47
Emergency Calls 47
Enh. Priv. Conversation Call
 Placing 36
 Receiving 38
Enter Key 14
Extended Range Operation 54

F

F1/F3 Switches 13, 14, 17
Failsoft Operation 47
FCN Switch 12, 17
Features
 Conventional 6, 25
 General 6
 SMARTNET 6, 34
 SmartZone 6, 49

H

Hazardous Area Classifications 56
Home Zone 19

I

Intrinsically Safe Rating 55

K

Keypad 14

L

Licensing 54
Low Battery 18

M

Messaging 45

Monitor Mode 26
Monitoring Before Transmitting 25

N

Non-Incendive Rating 55
Nuisance Channel Delete 23

O

On-Off/Volume 11, 16
Option Switch 9, 17
 Backlight 17
 Call Alert 44
 Call Response 38, 41
 Displayed Information 25
 Emergency 47
 High/Low Power 29
 Home Zone 19
 Keypad Lock 18
 Message 45
 Monitor 26
 Normal/Selective 26, 28
 Phone 42, 43
 Priority 32
 Private Call 36, 38, 39, 41, 45
 Radio Wide Scan 21
 Repeater Talk-Around 29
 Scan 21, 30
 Scan Edit 31
 Site Lock 50
 Site Search (SmartZone) 49
 Status 46
 Tones On-Off 20
 Zone 19

P

Paging 44
 Answering 45
 Initiating 44
Penalty Timer 28
Power Output Select 29

- Priority Calls
 - Conv 32
 - SmartNet 48
 - Priv. Conversation II Calls
 - Placing 39
 - Receiving 41
 - Private Calls 36
 - Programming 54
 - PTT Switch 12
- R**
- Repeater Talk-Around 29
 - RX Indicator 11
- S**
- Safety Information 4
 - Scan List 22
 - Channel Delete 23
 - Conventional Mode 30
 - Determining Channels in 23
 - Programming 31
 - Radio Wide Scan Mode 22
 - Selecting 30
 - Standard Scan Mode 22
 - Scan Mode
 - Transmitting In 31
 - Scan Resume Delay 22
 - Scanning 20
 - Conventional 30
 - Radio Wide 20, 21
 - SmartNet 48
 - Standard 20, 21
 - Scroll Left Key 14
 - Scroll Right Key 14
 - Servicing 55
 - Site
 - Locking/Unlocking 50
 - Searching for 49
 - Site ID (SmartZone) 49
 - SMARTNET Mode 23
 - SmartZone Mode 23
 - Speaking Into Microphone 54
 - Standard Calls
 - Placing (Conv) 33
 - Placing (SMARTNET) 35
 - Receiving (Conv) 33
 - Receiving (SmartNet) 35
 - Status Messages 46
 - Supervisory Tones 50
- T**
- Talk-Around, Repeater 29
 - Telephone Calls
 - Placing 41
 - Receiving 43
 - Time-Out Timer 19
 - Tone Enable/Disable 20
 - Tones 50
 - Top Panel Controls 11
 - Traffic Channel 24
 - Transmit Disable On Busy 27
 - Transmitting, Scan Mode 31
 - Troubleshooting 55
 - TX Indicator 11
- U**
- Unit ID 16, 34
- V**
- Volume Level, Setting 17
- W**
- Warranty 3
- Z**
- Zone Select 19



Part Number 002-7781-500
9-00hph Printed in U.S.A